



# EZZY WAVE TUNING GUIDE

(4 batten , sizes: 2.8 to 5.5)

## l) Setting the Downhaul When You HAVE the Correct Ezzy Mast:

- a) First, check that the length of your Ezzy mast falls within the recommended lengths (chart 1).
- b) If your mast is **LONGER**, move the downhaul gauge **DOWN** by the difference.
- c) If your mast is **SHORTER**, move the downhaul gauge **UP** by the difference.

**Note:** Use the factory drawn medium line on the sail as your reference.

d) Then, downhaul your sail until the calibration mark lines up with the bottom of the mast (Fig. 1).

e) Refer to Fig. 2 for which line to use of the downhaul gauge.

### **Additional Information:**

- We have set the adjustable head cap to its shortest setting. This ensures the downhaul gauge accuracy.
- Do not downhaul beyond the MAX line. Too much downhaul will make the sail unstable and lack power.
- To get the best performance, adjust the downhaul and outhaul together. For example, if you increase the downhaul for strong wind, you should also increase the outhaul. And, for light wind, to get maximum power, reduce the outhaul as well as the downhaul.
- See Chart 2 for additional tuning tips.

Sail Size	Mast		
	Bottom	Top	Length
2.8, 3.0	315	340	315.5
3.4, 3.7	340	340	340.5
4.0	340	370	355.5
4.2, 4.5	370	370	370.5
4.7, 5.0	370	400	385.5
5.2	400	400	400.5
5.5,	400	430	415.5
5.8, 6.8	430	430	430.5

Chart 1: First choice mast combinations and lengths.

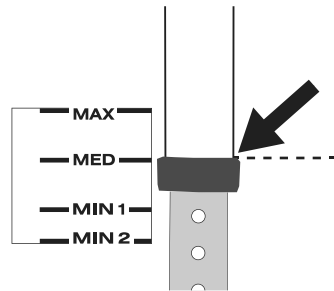

Fig. 1: Downhaul until the calibration mark lines up with the bottom of the mast.

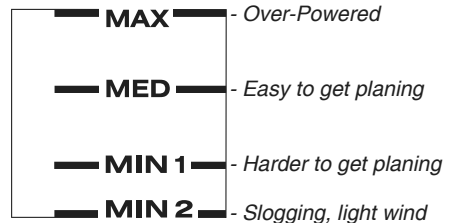

Fig. 2: Downhaul Gauge with suggested settings.

## II) Setting The Downhaul For A Second Choice Mast

a) Set your mast extension to the medium extension height.

b) Slide your mast into the luff sleeve, making sure the mast sits above the battens (figure 3). **Do not apply any outhaul.**

c) Begin downhauling slowly while observing the front of the foot batten. Continue downhauling just until the front of the foot batten “pops” to side of the mast (figure 4) and then stop downhauling.

d) This is your medium wind setting.

e) Now, remove the downhaul gauge from the velcro and move it so that the medium mark lines up with the bottom of your mast (figure 1).

f) The downhaul gauge is set. From now on, just downhaul until the gauge lines up with the bottom of your mast.

### **Additional Information:**

- See Fig. 2 for an suggestions on which line to use of the downhaul gauge.

- See Chart 2 for trouble-shooting.

## III) Tension the Tack Strap

a) The tack strap requires a lot of tension. Its purpose is to tension the foot and add shape to the bottom of the sail. It also lowers the sail's center of effort. When properly tensioned, the tack strap will improve your sail's performance and handling.

You always want a lot of tension on the tack strap.

b) Tension the strap until you see a wrinkle extending out from the tack, see Fig 5.

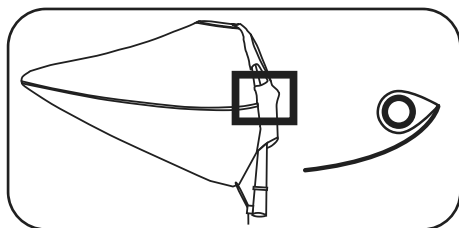

Figure 3: Insert the mast above the battens.

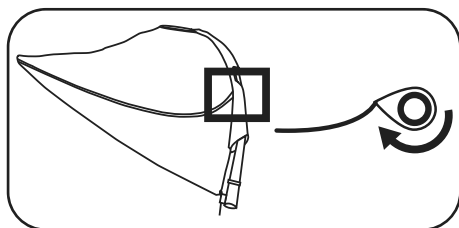

Figure 4: Downhaul slowly until the front of the foot batten “pops” to the side of the mast.

Problem	DH	OH	TS
Unstable	+2mm	+1cm	High
Twitchy	-2mm	-1cm	High
Back Handy	-2mm	+1cm	High
Front Handy	+2mm	-1cm	High
No Power	-2mm	-1cm	High
Over-Powered	+2mm	+1cm	High
Heavy Feeling	+2mm	+2cm	High

Chart. 2: Tuning at the beach.  
DH=downhaul, OH=outhaul,  
TS= tack strap

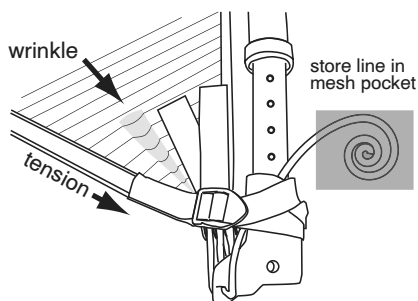

Fig. 5: Tension tack strap

## **IV) Setting the Outhaul**

The Ezzy Wave requires positive outhaul (Fig. 6).

The three cords sewn at the clew indicate how much positive outhaul is needed for varying wind conditions. The longest cord shows the maximum outhaul for strong wind; the shortest cord indicates the minimum outhaul for light wind and the middle cord shows a medium outhaul setting.

### **Follow these steps to set the outhaul:**

- a) First, correctly set the downhaul.
- b) Next, release all outhaul tension.
- c) Make sure the battens are all rotated under the mast.
- d) Then, gently pull on the outhaul cord and set your boom to the end of the cord (Fig. 7).
- e) Finally, outhaul your sail to the end of the boom (Fig. 8).

### **Additional Information:**

- When setting your boom to the cord, don't pull the clew.
- We suggest starting with the medium length cord. If you feel over-powered (back-hand pressure), increase the outhaul about 1 to 2 cm. If you feel under-powered, reduce the outhaul by about 1 to 2 cm.

## **V) Tensioning the battens**

Use the tensioner key that is stored in the pad of the sail and tension the battens until you eliminate any vertical wrinkles that extend out from either side of the batten pocket (Fig. 9).

Note: Your battens have already been tuned by us in the factory and most likely will not need further tuning. Be careful not to over-tension your battens.

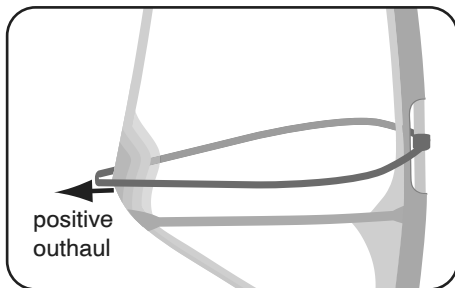

*Fig. 6: Positive outhaul*

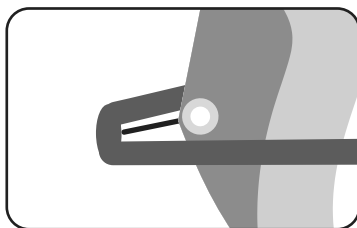

*Fig.7: Set the boom length to the outhaul cord*

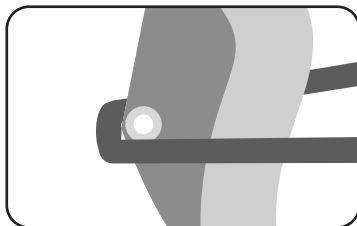

*Fig. 8: Outhaul sail to the end of the boom*

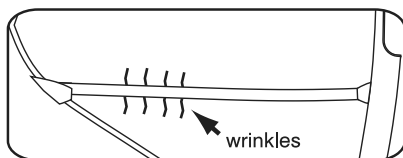

*Fig. 9: Tension the battens until there are no vertical wrinkles on either side of the batten pocket.*

## VI) Sail Care:

- To avoid mold and mildew, dry your sail thoroughly before storing it.
- Creasing damages the sail cloth. Avoid creasing your sail when rigging and de-rigging.
- Sunlight kills all sail cloth. Keep your sail out of the sun when not sailing.
- Don't rig on sharp objects.
- After rolling the sail, tuck the pad so it rests along the sail, wrap the tack strap around the pad and the sail, then attach the velcro (Fig. 10).
- Insert your sail sleeve-end first into the sail bag (Fig. 11).
- Never store your sail upright resting on the clew.



*Fig. 10: After rolling, tuck the pad, then wrap with the tack strap and secure the velcro.*



*Fig. 11: Insert with the sleeve-end first into the sail bag and store horizontal.*

## VII) Basic Theory Relating to Outhaul and Downhaul:

- Adding downhaul, in addition to loosening the leech, moves the **draft back** because it flattens the luff.
- Adding outhaul, in addition to flattening the sail, reduces tension along the luff and moves the **draft forward**.

**It is important to adjust the downhaul and outhaul together.**

- 1) If your sail feels unstable, give a few millimeters of downhaul and a few centimeters of outhaul.
- 2) If your sail feels stable, but has back-hand pressure, give a couple of centimeters of outhaul until the back hand pressure goes away.
- 3) If your sail feels "stiff" and wants to pull you forward, release some outhaul and possibly increase the downhaul.
- 4) If your sail lacks power, reduce downhaul and outhaul.

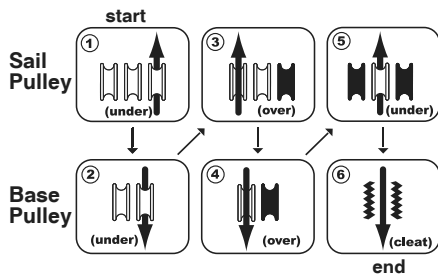

*Fig. 12: Threading the tack pulley for a Chinook-style extension.*